



Crosshatch

FilaSorb™ 12

acoufelt
making quiet

Product Detail

Product	Crosshatch
Surface	Wall
Composition	100% Polyester
Material	FilaSorb™
Recycled Content	60% min.
Thickness	12mm 0.47" +/- 10%
Weight	0.49 lb/ft ² +/- 10%
Dimension	12"W x 12"H
	Custom size available upon request.

Technical Data

Fire Test Method Number	AS ISO 9705:Group 1 ASTM E84-17a Class A
Indoor Air Quality	Low VOCs emission, formaldehyde and Phenol-free
Light Fastness	ISO 105-B02 1994, 6-7

Acoustic Performance

Sound Absorption ISO 354-2006 NRC 0.45

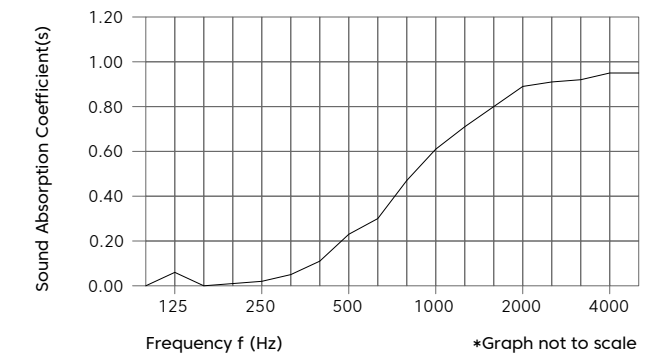

Frequency f(Hz)	125	250	500	1000	2000	4000	NRC
12mm α _s	0.06	0.02	0.23	0.61	0.89	0.95	0.45

Guarantees

Lead Time	Ships in 4-6 weeks
Light Fastness Warranty	10 Years*
Customizable	Yes

* conditions apply

Environmental Attributes

- Declare Certification
- LCB Red List Free
- Phenol And Formaldehyde Free
- Low VOC
- CDPH Compliance
- Aligns With Building Standards



Crosshatch Pattern

Crosshatch

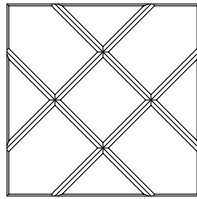

Recommended Layouts

Layout 1

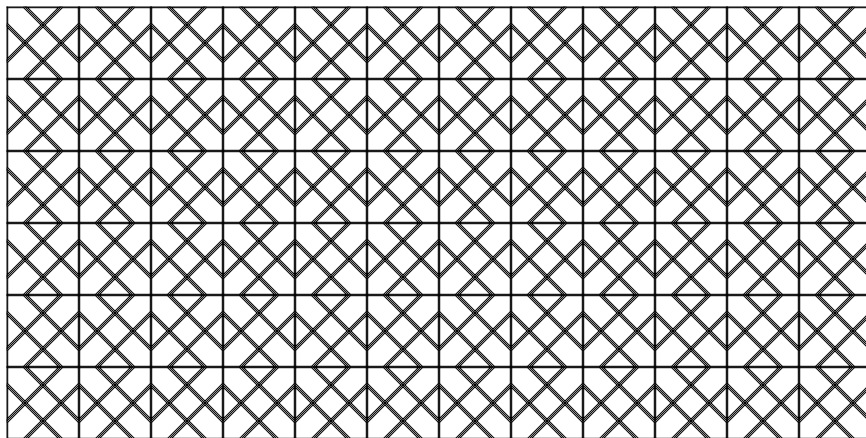

Layout 2

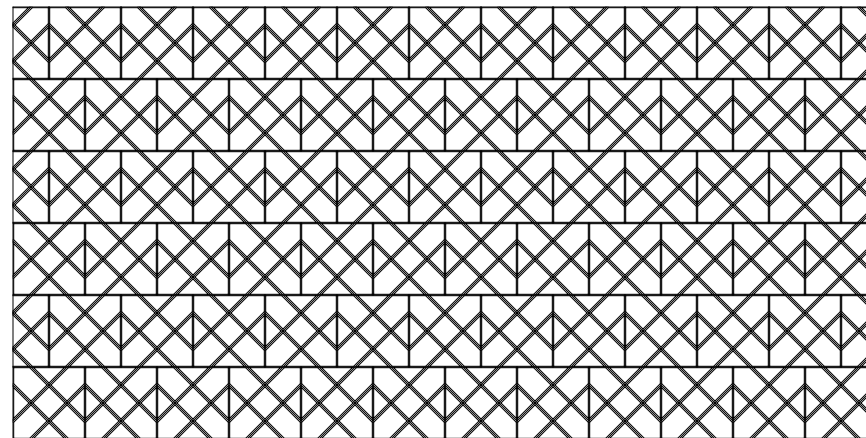

Mounting Methods

Adhesive Backing

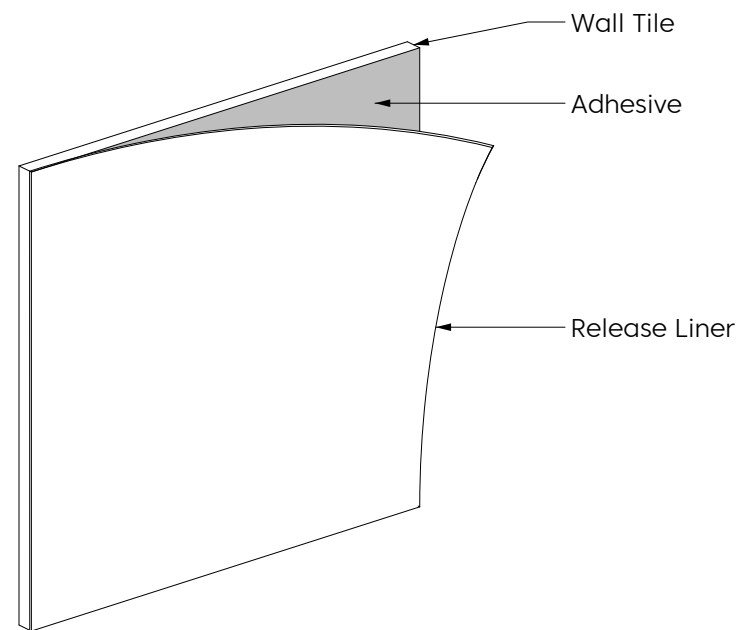

Construction Adhesive

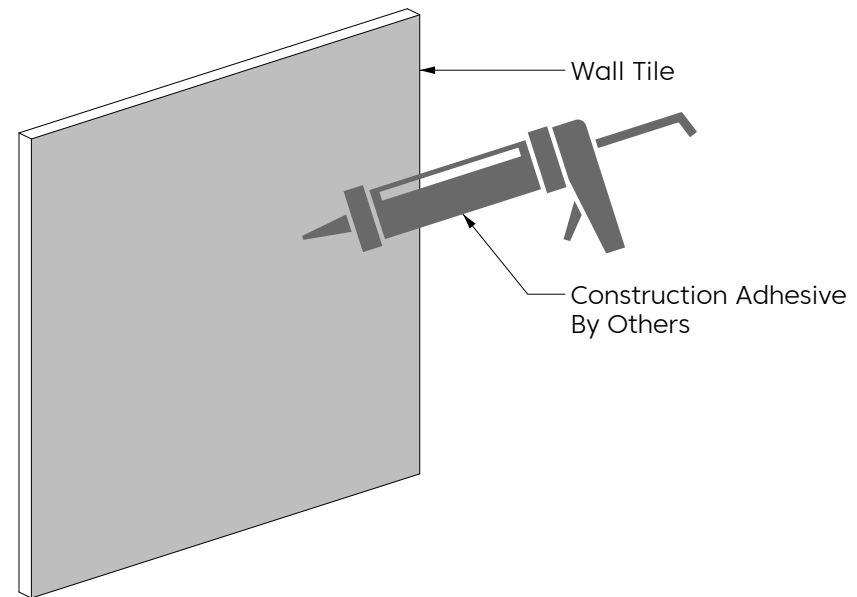

Colorways



Lipstick Red
LI14



Carrot
CA08

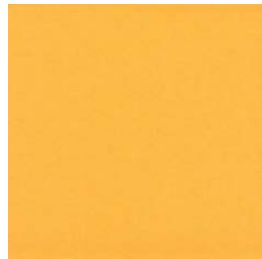

Butter
BU07



Popcorn
PO26



Pistachio
PI25

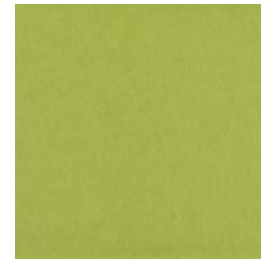

Wasabi
WA29



Thistle
TH28

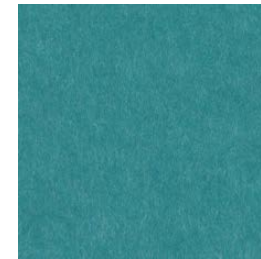

Peacock
PE20



Oregano
OR18



Kale
KA12



Denim
DE09



Midnight
MI16



Azur
AZ05



Marine
MA15



Periwinkle
PE23



Iris
IR10



Berry
BE06



Lilac
LI13

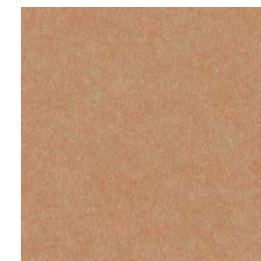

Peach
PE19

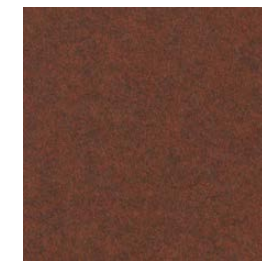

Peppercorn
PE22



Piano Black
PI24



Charcoal
CH01

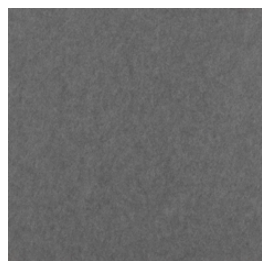

Slate
SL27



Grey
GR02



Metal
ME03



Platinum
PL04



White
WH12



Pearl
PE21



Ivory
IV11